



DuraCast™ Fiberglass Columns

Timeless beauty and elegance come standard with all Dixie Pacific® columns. For extreme durability, minimal maintenance, and designs for both interior and exterior applications, DuraCast™ Fiberglass Columns are exactly what you've been looking for.

Choosing the Right DuraCast™ Column

1. Choose the column style: *round, square, tapered or non-tapered; plain or fluted.*
2. Choose the appropriate column size.
3. Select the appropriate cap and base.

DuraCast™ Columns are designed for all types of decorative and load-bearing installations. They are manufactured from highly advanced fiberglass reinforced polymers (FRP), which makes them very durable. All components are insect, weather, and decay resistant and carry a limited lifetime warranty. With architecturally correct proportions and projections, DuraCast™ Columns are available in a range of styles to fit any project. Each must pass quality control inspections before it is shipped, making sure that each represents the unmistakable Dixie craftsmanship.



DuraCast™ Column Features:

- Round or Square
- Architecturally Correct Proportions
- Plain or Fluted Shaft
- Durable
- Low Maintenance
- Decay Resistant
- Load Bearing
- Decorative Capitals Available
- Limited Lifetime Warranty

DuraCast™ Fiberglass Column Styles



Round Tapered (Plain or Fluted)

Round Non-Tapered (Plain or Fluted)

Square Fluted

Square Plain

Square Recessed Panel

Square Applied Panel

Craftsman

Caps & Base/Plinths for DuraCast™ Columns

See Page 7 for details

TUSCAN
CAP & BASE



ROMAN DORIC
CAP & BASE



COLONY
CAP & BASE



ATTIC
BASE



Decorative Capitals for DuraCast™ Columns

ANGULAR GREEK IONIC



EMPIRE



MODERN
COMPOSITE



ANGULAR GREEK IONIC
W/ NECKING



EMPIRE W/ NECKING



ROMAN IONIC



ROMAN
CORINTHIAN



DECORATIVE ROMAN
DORIC



GREEK ERECTHEUM



SCAMOZZI



TEMPLE OF WINDS



Fiberglass Column Installation Kit

Sold
Separately



Use during installation to
secure column shaft in place.

Each Kit Includes:

- (4) Brackets (2 top; 2 bottom)
- (10) 2" Stainless Screws
- (10) Tapcon Screws

Split Column Assembly Kit

Dixie Pacific® offers a split column assembly kit that utilizes a mechanical fastening system for easy and secure assembly. This kit can be purchased separately when ordering a factory split column or they can be ordered pre-installed on factory split columns. This kit is available on select sizes.

Plan Types for Split DuraCast™ Columns





DuraCast™ Round Tapered Columns



Size	Bottom Dia	Neck Dia	Base Plinth Width	Base Plinth	Base Moulding	Capital Square Width	Capital Square	Capital Round	Bead	Bottom Flute	Top Flute	Flute Width	Above Bead	Number of Flutes	Lengths Available
	A	B	C	D	E	F	G	H	I	J	K	L	M	-	
6"	5-5/8"	5-1/2"	8-1/4"	1-1/2"	1-3/4"	7-1/8"	1-1/8"	5/8"	1"	10-3/4"	1"	5/16"	3-1/4"	16	5', 6', 8', 9', 10'
8"	7-5/8"	6 1/2"	10-1/4"	1-7/8"	2-3/8"	9-9/16"	1-3/8"	1"	1"	10-3/4"	1"	11/16"	4-1/4"	24	5'-6", 6', 8', 9', 10'
10"	9-5/8"	8-1/2"	12-7/8"	2-3/8"	2-7/8"	11-7/8"	1-3/4"	1-1/4"	1"	10-3/4"	1"	7/8"	5-1/8"	24	6', 8', 9', 10', 12'
12"	11-5/8"	10"	15-1/4"	2-3/4"	3-1/4"	14-1/2"	2"	1-3/8"	1"	10-3/4"	1"	1"	5-7/8"	24	6', 8', 9', 10', 12', 14', 16'
14"	13-5/8"	12"	18-3/4"	3-3/8"	4"	17-1/4"	2-3/8"	1-5/8"	1-1/8"	10-3/4"	1"	1"	6-7/8"	24	8', 9', 10', 12', 14', 16'
16"	15-5/8"	13-1/2"	21-1/4"	3-7/8"	4-1/2"	19-1/4"	2-3/4"	1-7/8"	1-1/4"	10-3/4"	1"	1-1/4"	7-1/2"	24	8', 9', 10', 12', 14', 16', 18', 20'
18"	17-1/2"	15-3/8"	24-5/8"	4"	5-5/8"	22-3/8"	3-1/8"	2-3/4"	1-1/8"	10-3/4"	1-1/2"	1-3/8"	8-7/8"	24	10, 12, 14, 16, 18, 20, 22, 24, 26
20"	19-1/2"	17-3/16"	27"	4-3/4"	6-1/2"	24-15/16"	3-3/8"	2-7/8"	1-7/16"	10-3/4"	1-1/2"	1-3/8"	9"	24	10, 12, 14, 16, 18, 20, 22, 24
22"	21-5/8"	19-1/4"	30-1/4"	5-3/8"	6-7/8"	27-1/2"	3-3/4"	3"	1-7/8"	10-3/4"	1-1/2"	1-11/16"	10-1/4"	24	16, 18, 20, 22, 24, 26
24"	23-5/8"	21-1/4"	33-1/2"	5-7/8"	7-7/16"	30-1/2"	4-1/16"	3-1/2"	2-3/16"	10-3/4"	1-1/2"	1-11/16"	11-5/16"	24	12, 14, 16, 18, 20, 22, 24, 26, 28, 30
28"	28"	24-1/8"	38"	6-3/4"	8-3/4"	33-3/8"	4-3/4"	3-1/4"	2-1/8"	10-3/4"	1-1/2"	2"	11-3/4"	24	20, 22, 24, 26, 28
30"	29-5/8"	26-1/2"	41-1/8"	6-1/2"	8-3/8"	38-1/4"	4-5/8"	4"	3-1/16"	10-3/4"	1-1/2"	2"	14-7/8"	24	20, 22, 24, 26, 28, 30



- NOTE:
- Custom Fluted Columns are available.
 - Custom sizes are available. Contact Dixie Pacific® for more information.
 - Standard Fluted Column (Fluted in mold)

Columns to Surround Structural Supports

for DuraCast™ Round Tapered Columns

Size	Max Round Support	Max Square Support
6"	3"	2 1/2"
8"	5 1/4"	3 11/16"
10"	6 7/8"	4 13/16"
12"	8 7/16"	5 7/8"
14"	10 1/16"	7 1/8"
16"	12 7/8"	9 1/8"
18"	14 3/8"	10 3/16"
20"	16 5/8"	11 3/4"
22"	18 1/4"	12 7/8"
24"	20 1/4"	14 1/4"
28"	22"	15 1/2"
30"	25 1/4"	17 3/4"

Top View

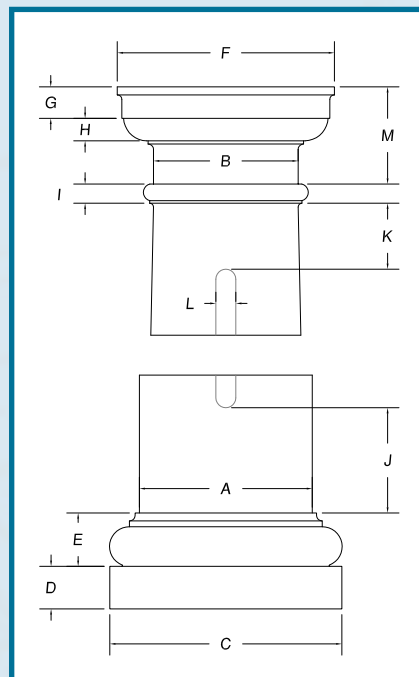

- NOTE:
- Inside diameter may vary up to 1/4". These columns allow for saw kerf as columns are split.
 - Columns that are split are non-load-bearing. Splitting a column will decrease inside dimension 1/8".
 - Specify shape and size of structural support



Measurements in inches unless otherwise noted. There may be a variance of up to 1/4" in all dimensions.
NOTE:

- Tuscan Cap and Base are standard components for DuraCast™ Columns.
- All Caps and Base are non-vented.
- All Caps and Base are sold separately from the column.

Tuscan Cap & Base

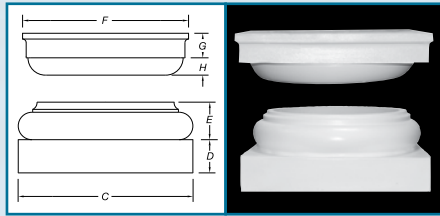

Column Size	Plinth		Base Mould	Cap (Square)		Cap (Round)
	Width	Height		Width	Height	
	C	D	E	F	G	H
6"***	8-1/4"	1-1/2"	1-3/4"	7-1/8"	1-1/8"	5/8"
8"***	10-1/4"	1-7/8"	2-3/8"	9-9/16"	1-3/8"	1"
10"***	12-7/8"	2-3/8"	2-7/8"	11-7/8"	1-3/4"	1-1/4"
12"***	15-1/4"	2-3/4"	3-1/4"	14-1/2"	2"	1-3/8"
14"*	18-3/4"	3-3/8"	4"	17-1/4"	2-3/8"	1-5/8"
16"*	21-1/4"	3-7/8"	4-1/2"	19-1/4"	2-3/4"	1-7/8"
18"*	24-5/8"	4"	5-5/8"	22-3/8"	3-1/8"	2-3/4"
20"*	27"	4-3/4"	6-1/2"	24-15/16"	3-3/8"	2-7/8"
22"*	30-1/4"	5-3/8"	6-7/8"	27-1/2"	3-3/4"	3"
24"*	33-1/2"	5-7/8"	7-7/16"	30-1/2"	4-1/16"	3-1/2"
28"*	38"	6-3/4"	8-3/4"	33-3/8"	4-3/4"	3-1/4"
30"*	41-1/8"	6-1/2"	8-3/8"	38-1/4"	4-5/8"	4"

NOTE:

- Available in Polyurethane and Injection Molded (SIM/ER) for 6"-12".
- It is not recommended to split Injection Molded (SIM/ER) Cap and Base sets for reassembly.
- Tuscan (SIM/ER) Cap and Base components can only be purchased as a set.
- Tuscan cast fiberglass Caps and Bases are available for 6"-16".

Colony Cap & Base

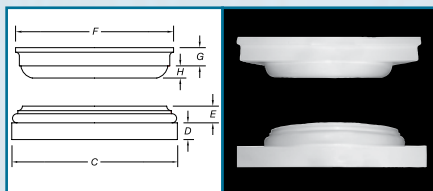

Column Size	Plinth		Base Mould	Cap (Square)		Cap (Round)
	Width	Height		Width	Height	
	C	D	E	F	G	H
6"*	7-7/8"	1-1/4"	1-1/2"	7"	1	5/8"
8"***	9-7/8"	1-1/4"	1-1/2"	9-3/8"	1"	1"
10"***	11-7/8"	1-1/4"	1-1/2"	11-3/8"	1-1/4"	1"
12"*	13-3/4"	1-1/4"	1-1/2"	12-7/8"	1-3/8"	1"

NOTE:

- Available in Polyurethane and Injection Molded (SIM/ER) for 8"-10".
- It is not recommended to split Synthetic Injection Molded (SIM/ER) Cap and Base sets for reassembly.
- Colony (SIM/ER) Cap and Base components can only be purchased as a set.

Roman Doric Cap & Base

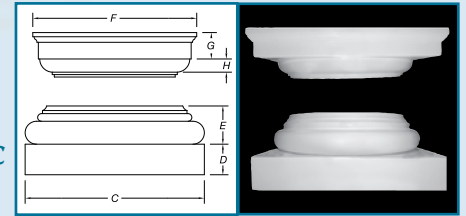

Column Size	Plinth		Base Mould	Cap (Square)		Cap (Round)
	Width	Height		Width	Height	
	C	D	E	F	G	H
6"*	8 1/2	1 1/2	1 3/4	7 7/8	1 1/8	5/8
8"*	10 3/8	1 7/8	2 7/16	9 3/4	1 7/16	1 1/16
10"*	12 15/16	2 3/8	3 1/8	12 1/2	1 3/4	1 9/16
12"*	15 1/4	2 3/4	3 1/2	14 3/4	2 3/16	1 1/2
14"*	18 3/8	3 3/8	4 1/16	17 1/2	2 5/16	2 1/16
16"*	21 1/2	3 7/8	4 7/8	19 7/8	2 5/8	2 1/16
18"*	23 1/4	4	6	23 1/8	3	1 3/4

NOTE:

- Roman Doric cast fiberglass Caps and Bases are available for 6"-16".

Attic Base

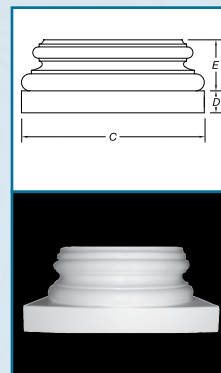

Column Size	Plinth		Base Mould
	Width	Height	
	C	D	E
6"*	8 1/2	1 1/2	2 7/16
8"*	10 1/4	1 7/8	3 1/4
10"*	13	2 3/8	3 7/8
12"*	15 1/4	2 3/4	4 1/2
14"*	18 3/8	3 3/8	5 3/8
16"*	21 1/2	3 7/8	6 1/4
18"*	25	4 3/8	7 1/4
20"*	27 11/16	4 7/8	8 1/4
22"*	30 1/4	5 3/8	9 1/4
24"*	33 1/2	6	10 1/4
28"***	38	6 3/4	11 3/8
30"*	41 1/4	6 1/2	11 1/4

NOTE:

- Attic cast fiberglass bases are available.

* Manufactured from polyurethane.

** Manufactured from polyurethane or Synthetic Injection Molded (SIM/ER).

*** Manufactured from fiberglass.



Don't settle for anything less than the top of the line for the top of your column. Reminiscent of time-honored architectural styles, Dixie Pacific's® wide range of Decorative Capitals allows you to make a modern-day statement for any fiberglass or paint-grade wood column for both interior and exterior applications.

Decorative Capital Features:

- 12 Styles and Numerous Sizes Available
- Decay Resistant
- Hand Crafted with Precise Detail
- Manufactured from Lightweight Polyurethane
 - 6"-12" are Load-Bearing
 - 14"-30" Requires Load-Bearing Plug
- Limited Lifetime Warranty

Measurements in inches unless otherwise noted. There may be a variance of up to 1/4" in all dimensions.

NOTE:

- 8" - 12" Decorative Capitals are load bearing (unless split) and manufactured from lightweight polyurethane.
- 14" - 30" Decorative Capitals are non-load bearing (requires plug) and manufactured from lightweight polyurethane.
- Specify shape and size of structural support if Decorative Capitals are split for reassembly. The inside diameter of the Decorative Capital is significantly smaller than the inside top diameter of the column shaft.
- Fiberglass Decorative Capitals are available.

**Necking detail may vary.

Cutting Columns at Bead/Astragal

A. All DuraCast™ Round Tapered Fiberglass Columns and Paint-Grade (6" x 8' - 12" x 12') Round Tapered Wood Columns used with Decorative Capitals should be cut flush above the bead.

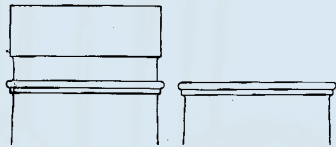

B. The Decorative Capital should rest on top of the bead to allow for a proper fit on the column.

The "cut at bead" loss and the Decorative Capital height must be taken into consideration when ordering columns. A column used with a short Decorative Capital may require a longer shaft.



Greek Erectheum with Necking**



Greek Ionic



Greek Erectheum



Angular Greek Ionic



Angular Greek Ionic with Necking**



Scamozzi

Plan Types for Split Decorative Capitals

Q

C

D

H

K



Roman Ionic



Empire



Empire with Necking**



Decorative Roman Doric

"Cut At Bead" Loss for DuraCast™ Round Tapered Fiberglass Columns
Measurement in inches unless otherwise noted.

Column Size	"Cut at Bead" Loss
6"	3-1/4"
8"	4-1/4"
10"	5-1/8"
12"	5-7/8"
14"	6-7/8"
16"	7-1/2"
18"	8-7/8"
20"	9"
22"	10-1/4"
24"	11-5/16"
28"	11-3/4"
30"	14-7/8"

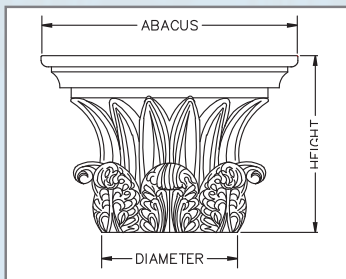

Temple of Winds

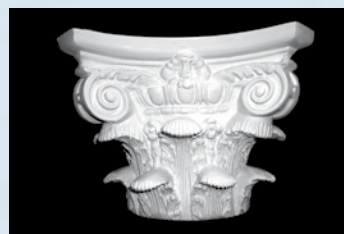

Modern Composite



Roman Corinthian



DuraCast™ Round Non-Tapered Columns

Custom flutes available

Column Size	Bottom Shaft Diameter	Neck Shaft Diameter	Bead (Applied)	Length (in feet)
	A	B	K	
6"	5 5/8	5 3/8	3/4	8, 9
8"	7 5/8	7 5/8	3/4	6, 8, 9, 10
10"	9 5/8	9 5/8	3/4	6, 8, 9, 10, 12
12"	11 5/8	11 5/8	13/16	6, 8, 9, 10, 12
14"	13 3/8	13 5/8	7/8	6, 8, 9, 10, 12, 14
16"	15 3/4	15 3/4	1	6, 8, 9, 10, 12, 14, 16, 18, 20
18"	17 1/2	17 1/2	1 1/8	6, 8, 9, 10, 12, 14, 16, 18, 20
24"	24	24	2 3/16	8, 10, 12, 14, 16, 18, 24

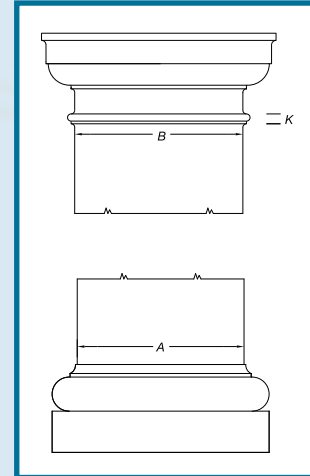

- NOTE:
- All DuraCast™ fluted columns have adjustable flutes which can be altered.
 - Beads are sold separately.
 - Custom sizes are available. Contact Dixie Pacific® for more information.

Columns to Surround Structural Supports

for DuraCast™ Round Non-Tapered Columns

Column Size	Inside Top Shaft Diameter
	P
8"	6 7/8
10"	8 7/8
12"	10 7/8
14"	12 7/8
16"	15
18"	16 3/8
24"	21

Top View

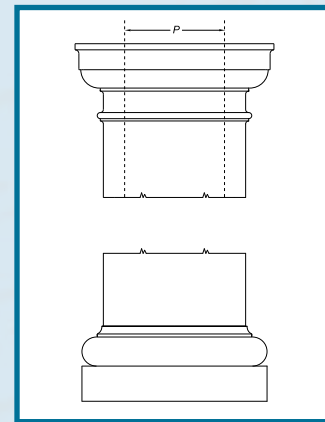
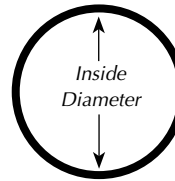

- NOTE:
- Inside diameter may vary up to 1/8". These columns allow for saw kerf as columns are split. Columns that are split are non-load-bearing. Splitting a column will decrease inside dimension 1/8".
 - Specify shape and size of structural support.

Tuscan Cap & Base

for DuraCast™ Round Non-Tapered Columns

Column Size	Plinth		Base Mould	Cap (Square)		Cap (Round)
	Width	Height		Width	Height	
	C	D	E	F	G	H
6"	8 1/4	1 1/2	1 3/4	8 1/4	1 1/8	5/8
8"	10 1/2	1 7/8	2 1/2	10 5/8	1 1/2	1 1/4
10"	13 1/8	2 3/8	2 7/8	12 13/16	1 3/4	1 1/4
12"	16 1/2	2 7/8	3 1/4	15 7/8	2	1 3/4
14"	19 1/2	3 3/8	4 1/4	19 1/8	3	2 1/4
16"	22 1/8	4	4 5/8	22	2 3/4	2 1/4
18"	24 3/8	4	5 5/8	24 3/8	3 1/8	2 3/4
24"	33 1/2	5 3/4	7 7/16	33 3/8	4 1/8	3 1/2

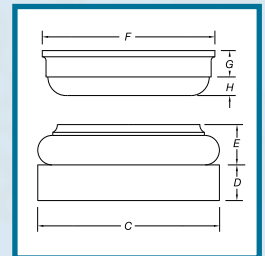

Bead is adjustable and is applied in the field.

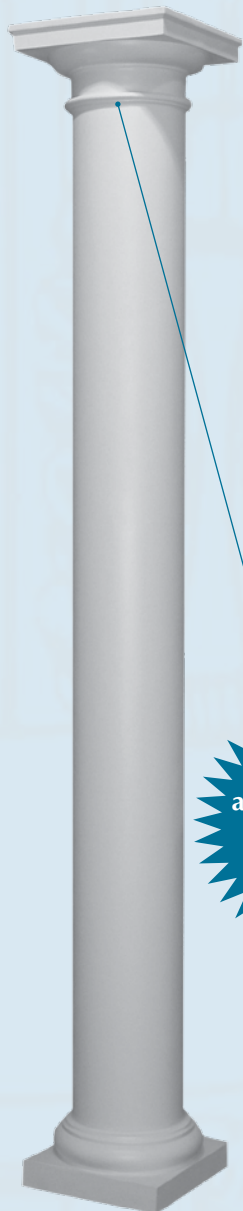



Four New Sizes

DuraCast™ Craftsman Column Dimensions

	A	B	C	D	E	F	G	J	K	L	R	LENGTH
10" x 5 1/2"	10"	5 1/2"	13"	2 1/2"	2 3/8"	1 1/16"	1"	1 3/8"	1 3/8"	9 5/8"	5 7/8"	66"
10 1/4" x 7 1/2"	10 1/4"	7 1/2"	13 1/2"	2 3/8"	2 1/4"	3/4"	1"	1"	1"	10 1/4"	5 3/8"	7'
10" x 8"	9 1/2"	7 1/2"	12 3/4"	2 3/8"	2 1/8"	3/4"	1"	1"	1 3/8"	10 1/4"	5 1/4"	66"
12" x 10"	12"	10"	16 9/16"	2 1/2"	2 1/2"	1 1/16"	1"	1 3/8"	1 3/8"	12 3/4"	6 1/16"	6', 10'
14" x 12"	14"	12"	18 3/4"	3 3/8"	3"	1"	1"	1 5/8"	2"	17 1/8"	7 3/8"	9'
16" x 9"	16"	9"	18 3/4"	2 1/2"	2 1/2"	1 1/16"	1"	1 3/8"	1 3/8"	13 1/4"	6 1/16"	58"
16" x 9"	16"	9"	19 1/16"	2 1/2"	2 1/2"	1 1/16"	1"	1 3/8"	1 3/8"	13 1/4"	6 1/16"	6', 8'
16" x 12"	15 1/4"	11 1/2"	21 1/2"	3 7/8"	3 5/16"	1 3/16"	1"	1 3/8"	2"	15 1/4"	8 7/16"	58", 6', 8'

NOTE: Neck mould is not applied. Flashing and Installation Kit is not available for Craftsman Columns with Poly Tuscan cap and base sets.

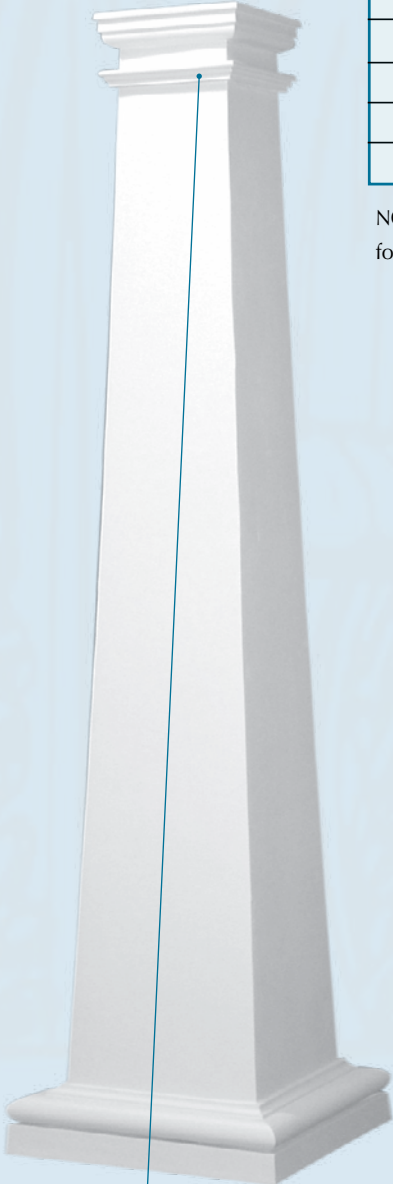

DuraCast™ Craftsman Tapered Columns

Column Size	Top	Bottom	
10" x 5 1/2"	4 1/2"	9"	
10 1/4" x 7 1/2"	6 1/2"	9 1/4"	
10" x 8"	6 1/2"	8 1/2"	
12" x 10"	9"	11"	
14" x 12"	11"	13"	
16" x 9"	8"	15"	
16" x 12"	10 1/2"	14 1/2"	

- NOTE:
- Inside width may vary up to 1/4".
 - These columns allow for saw kerf as columns are split. Columns that are split are non-load-bearing. Splitting a column will decrease inside dimension 1/8".
 - Specify shape and size of structural support.

Tuscan Cap & Base

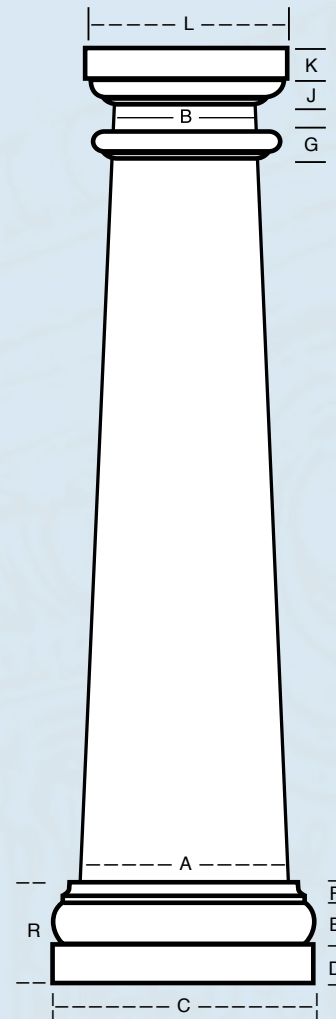

Bead is adjustable and is applied in the field.



Measurements in inches unless otherwise noted. There may be a variance of up to 1/4" in all dimensions.

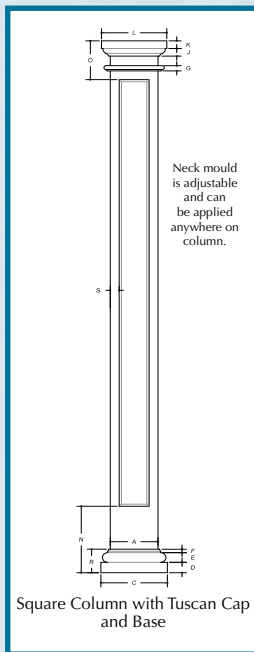

Versatility of Square Columns

The design and versatility of a Dixie Pacific® square column has enhanced its popularity with today's architects. The Dixie Square DuraCast™ column line up includes plain, recessed panel, and fluted. An unlimited combination of styles can be achieved by various uses of the panel moulding, neck moulding, and caps and bases. Additionally, the square column is not tapered and can be cut to any height without affecting the fit of the caps and bases.



RECESSED PANEL INSIDE DIMENSION

Inside dimension may vary up to 1/8".
Splitting a column will decrease inside dimension 1/8".

Col. Size	Inside
8"	5 5/8"
10"	7 1/2"
12"	9 1/2"
14"	11"

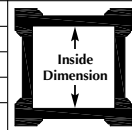

COLONY SQUARE CAP AND BASE

Col. Size	C	D	E	F	J	K	L	R
6"	8 1/8"	1 1/4"	1 1/16"	7/16"	5/8"	1"	7 7/16"	2 3/4"
8"	10 1/8"	1 1/4"	1 1/16"	7/16"	15/16"	1"	9 7/16"	2 3/4"
10"	12 1/8"	1 1/4"	1 1/16"	7/16"	15/16"	1 1/4"	12 1/8"	2 3/4"
12"	14 1/8"	1 1/4"	1 1/16"	7/16"	1"	1 3/8"	14 1/4"	2 3/4"

- Neck moulding is 4 pieces included with the cap and base.
- Low profile cap and base designed for railing applications.

SQUARE DURACAST™ RECESSED PANEL COLUMN DIMENSIONS*

Column Size	A	C	D	E	F	G	J	K	L	N	O	R	S	Recess Depth	Lengths Available (ft.)
8"	8"	11 1/8"	1 7/8"	1 3/4"	5/8"	1"	1 3/8"	1 3/8"	10 15/16"	12"	7"	4 1/4"	1 1/2"	1/2"	8,9,10
10"	10"	13 1/16"	2 1/4"	2 3/16"	3/4"	1 1/4"	1 1/4"	1 13/16"	12 3/4"	14 1/2"	8 1/2"	5 3/16"	1 1/2"	1/2"	8,9,10
12"	12"	16 9/16"	2 3/16"	2 3/8"	7/8"	1 1/4"	1 3/4"	2 1/16"	16 11/16"	18"	10 1/2"	6 1/16"	2 1/4"	3/16"	8,9,10,12,14
14"	14"	19 3/8"	3 5/8"	2 7/8"	1 1/16"	1 1/8"	2 1/16"	2 1/2"	19 1/16"	21"	12 1/4"	7 9/16"	2 5/8"	3/4"	8,10,14

* With Tuscan Cap and Base

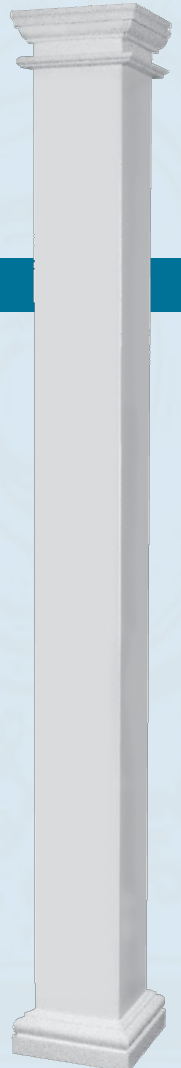

DURACAST™ SQUARE COLUMNS

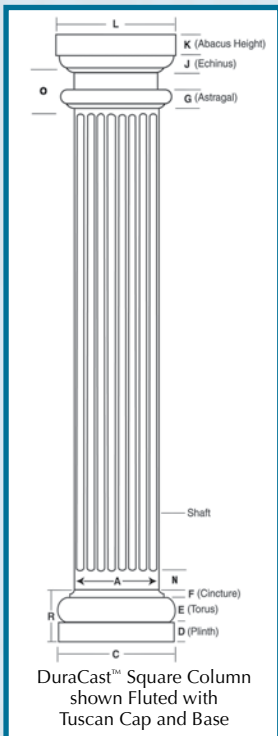

DuraCast™ Square Column shown Fluted with Tuscan Cap and Base

SQUARE DURACAST™ INSIDE DIMENSIONS

Inside dimensions may vary up to 1/8".
Splitting a column will decrease inside dimension 1/8".

COL. SIZE	INSIDE
6"	5 1/2"*
8"	6 7/8"
10"	9"
12"	11"
16"	14 3/4"

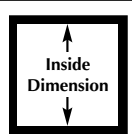

*Inside is Round

PANEL MOULDING FOR SQUARE DURACAST™

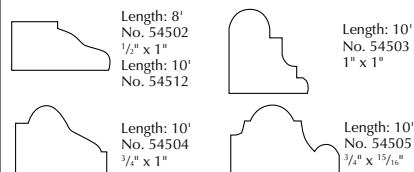

SQUARE DURACAST™ COLUMN DIMENSIONS*

Column Size	A	C	D	E	F	G	J	K	L	N	O	R	Lengths Available (ft.)
6"	6"	9 3/8"	1 1/16"	1 3/16"	5/8"	1"	1 1/4"	1 3/8"	9 3/8"	N/A	N/A	3 3/8"	6,8,9,10
8"	8"	11 1/8"	1 7/8"	1 3/4"	5/8"	1"	1 3/8"	1 3/8"	10 15/16"	4"	3 1/8"	4 1/4"	6,8,9,10,12
10"	10"	13 1/16"	2 1/4"	2 3/16"	3/4"	1"	1 1/4"	1 13/16"	12 3/4"	4"	4 1/8"	5 3/16"	51",6,8,9,10,12,14,16
12"	12"	16 9/16"	2 3/16"	2 3/8"	7/8"	1"	1 3/4"	2 1/16"	16 11/16"	N/A	N/A	6 1/16"	8,9,10,12,14,16,18
14"	14"	19 3/8"	3 5/8"	2 7/8"	1 1/16"	1"	2 1/16"	2 1/2"	19 1/16"	N/A	N/A	7 9/16"	8,10,12,14,16,18,20
16"	16"	22 1/8"	3 7/8"	3 3/8"	1 1/8"	1"	2 3/8"	2 3/4"	21 1/2"	N/A	N/A	8 3/8"	8,10,12,14,16,18,20

■ Fluted Square.

*With Tuscan Cap and Base.